

SECTION 4 / SLIDING SCREEN DOORS

PRODUCT	PAGE
Aluminum roll form sliding screen door (assembled / KD).....	62
Extruded aluminum sliding screen doors (assembled / KD).....	62-64
Steel roll form sliding screen doors (assembled).....	64-65
Maui vinyl sliding screen door (assembled / KD)	65
Custom options for sliding screen doors (assembled / KD).....	66-67
Door list	68
Top hung universal mounting channel	69
Sliding screen channels and astragals	70
Sliding screen door measuring worksheet	71
Sliding screen door order form.....	72

Features

- 1-5/8" Roll form aluminum frame
- Black plastic **Anjac** handle assembly with strike plate & installation screws
- Non-handed with handle centered
- Stamped steel corners
- Charcoal fiberglass insect screening (on assembled doors)
- 1" Nylon spring tension roller with adjustment screw (plastic inserts are no longer standard)
- Extruded vinyl bug seal with flap & tear-off strips
- Assembled & K.D. widths available up to 61"
- Assembled & K.D. heights available up to 97" (specify handle height on doors over 84" tall)
- Precision SAFEGUARD packaging - complete with hardware (on assembled doors)

Standard Finishes

- Bronze, gray or white powder coated

Call for quote on any sizes or options not shown

3100 (Assembled)
Product Line: D3301

4100 (KD) *
Product Line: D3310

Door size up to

Door size up to

37" x 81"	37" x 97"
49" x 81"	49" x 97"
61" x 81"	61" x 97"

31" x 81"	31" x 97"
37" x 81"	37" x 97"
49" x 81"	49" x 97"
61" x 81"	61" x 97"

For KD kits - **Convenient six pack packaging:**
Deduct \$2.00 per door (subject to discount)

*All rails are miter cut

Roll Form Aluminum
Screen Door

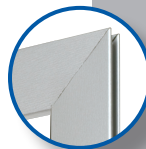

Features

- 1-3/4" .050 Extruded aluminum frame (fluted)
- Extruded aluminum handle assembly with mortise lock & lever latch
- Non-handed with handle centered
- Extruded aluminum spur corners
- Charcoal fiberglass insect screening (on assembled doors)
- 1" Steel ball bearing spring tension roller with adjustment screw (plastic inserts are no longer standard)
- Extruded vinyl bug seal with flap & tear-off strips
- Assembled & K.D. widths available up to 73"
- Assembled & K.D. heights available up to 110" (specify handle height on doors over 84" tall)
Extra charges will apply for doors over 97" in height
- Precision SAFEGUARD packaging - complete with hardware (on assembled doors)

Standard Finishes

- Adobe, almond, black, bronze or white powder coated
- Satin anodized

Call for quote on any sizes or options not shown

3200 (Assembled)
Product Line: D3302

4200 (KD) **
Product Line: D3311

Door size up to*

Door size up to*

37" x 81"	37" x 97"	37" x 110"
49" x 81"	49" x 97"	49" x 110"
61" x 81"	61" x 97"	61" x 110"
73" x 81"	73" x 97"	73" x 110"

31" x 81"	31" x 97"	31" x 110"
37" x 81"	37" x 97"	37" x 110"
49" x 81"	49" x 97"	49" x 110"
61" x 81"	61" x 97"	61" x 110"

*Doors over 97" tall are subject to an additional charge

For KD kits - **Convenient six pack packaging:**
Deduct \$2.00 per door (subject to discount)

**Miter cut service available for an additional charge

Extruded Aluminum
Screen Door

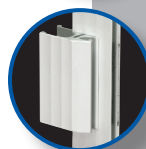

Extruded Aluminum Screen Door

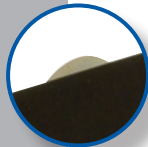
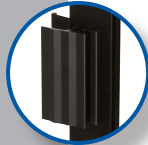
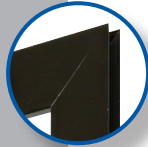
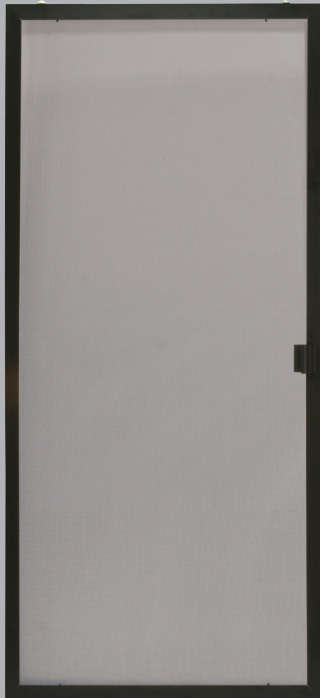

Features

- 1-3/4" .050 Extruded aluminum frame
- Extruded aluminum handle assembly with mortise lock & lever latch
- Non-handed with handle centered
- Heavy duty diecast corners with side adjustment
- Charcoal fiberglass insect screening (on assembled doors)
- 1-1/4" Steel ball bearing rollers
- Extruded vinyl bug seal with flap & tear-off strips
- Assembled & K.D. widths available up to 73"
- Assembled & K.D. heights available up to 110" (specify handle height on doors over 84" tall)
Extra charges will apply for doors over 97" in height
- Precision SAFEGUARD packaging - complete with hardware (on assembled doors)

Standard Finishes

- Adobe, almond, black, bronze or white powder coated
- Bronze or satin anodized

Call for quote on any sizes or options not shown

3300 (Assembled) Product Line: D3302

Door size up to*		
37" x 81"	37" x 97"	37" x 110"
49" x 81"	49" x 97"	49" x 110"
61" x 81"	61" x 97"	61" x 110"
73" x 81"	73" x 97"	73" x 110"

*Doors over 97" tall are subject to an additional charge

4300 (KD) ** Product Line: D3311

Door size up to*		
31" x 81"	31" x 97"	31" x 110"
37" x 81"	37" x 97"	37" x 110"
49" x 81"	49" x 97"	49" x 110"
61" x 81"	61" x 97"	61" x 110"

For KD kits - Convenient six pack packaging:
Deduct \$2.00 per door (subject to discount)

**Miter cut service available for an additional charge

MARQUIS (Series 3400 Assembled / 4400 KD)

Extruded Aluminum Screen Door

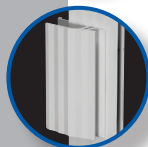

Features

- 2-1/2" .060 Extruded aluminum frame (fluted)
- Extruded aluminum handle assembly with mortise lock & lever latch
- Extruded aluminum spur corners
- Charcoal fiberglass insect screening (on assembled doors)
- 1" Steel ball bearing spring tension top rollers
- 1-1/4" Steel ball bearing bottom rollers
- Extruded vinyl bug seal with flap & tear-off strips

Specify handing: latch side, left or right as viewed from outside looking in

- Assembled & K.D. widths available up to 73"
- Assembled & K.D. heights available up to 110" (specify handle height on doors over 84" tall)
Extra charges will apply for doors over 97" in height
- Precision SAFEGUARD packaging - complete with hardware (on assembled doors)

Standard Finishes

- Adobe, almond, black, bronze or white powder coated
- Satin anodized

Call for quote on any sizes or options not shown

3400 (Assembled) Product Line: D3302

Door size up to*		
37" x 81"	37" x 97"	37" x 110"
49" x 81"	49" x 97"	49" x 110"
61" x 81"	61" x 97"	61" x 110"
73" x 81"	73" x 97"	73" x 110"

*Doors over 97" tall are subject to an additional charge

4400 (KD) ** Product Line: D3311

Door size up to*		
31" x 81"	31" x 97"	31" x 110"
37" x 81"	37" x 97"	37" x 110"
49" x 81"	49" x 97"	49" x 110"
61" x 81"	61" x 97"	61" x 110"

**Miter cut service available for an additional charge

Features

- 2-1/4" x 1" .050 Extruded "hat section" style aluminum frame (smooth)
- Recessed handle assembly with mortise lock & slide latch
- Non-handed with handle centered
- Extruded aluminum spur corners
- Charcoal fiberglass insect screening (on assembled doors)
- 1-1/4" Steel ball bearing rollers
- Extruded vinyl bug seal with flap & tear-off strips
- Assembled & K.D. widths available up to 73"
- Assembled & K.D. heights available up to 110" (specify handle height on doors over 84" tall)
Extra charges will apply for doors over 97" in height
- Precision SAFEGUARD packaging - complete with hardware (on assembled doors)

Standard Finishes

- Adobe, almond, bronze or white powder coated
- Satin anodized

Call for quote on any sizes or options not shown

3500 (Assembled)
Product Line: D3302

Door size up to*		
37" x 81"	37" x 97"	37" x 110"
49" x 81"	49" x 97"	49" x 110"
61" x 81"	61" x 97"	61" x 110"
73" x 81"	73" x 97"	73" x 110"

*Doors over 97" tall are subject to an additional charge

4500 (KD) **
Product Line: D3312

Door size up to*		
31" x 81"	31" x 97"	31" x 110"
37" x 81"	37" x 97"	37" x 110"
49" x 81"	49" x 97"	49" x 110"
61" x 81"	61" x 97"	61" x 110"

**Miter cut service available for an additional charge

Extruded "Hat Section" Aluminum Screen Door

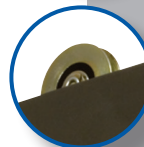
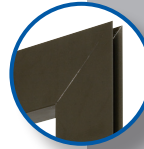

Features

- 1-5/8" Roll form steel frame
- Height adjustable from 79-3/8" to 80-3/4" (for height adjustments between 78-1/2" and 79", remove top hood assembly)
- 30", 36" & 48" Standard sizes
- Black plastic "Precision" handle assembly
- Non-handed
- Stamped steel corners
- Charcoal fiberglass insect screening
- Nylon spring tension roller assembly
- Top roller attached to adjustment channel
- Extruded vinyl bug seal with flap & tear-off strips
- No custom sizes or options
- Precision SAFEGUARD packaging - complete with hardware

Standard Finishes

- Bronze, gray or white

Economy Roll Form Steel Screen Door

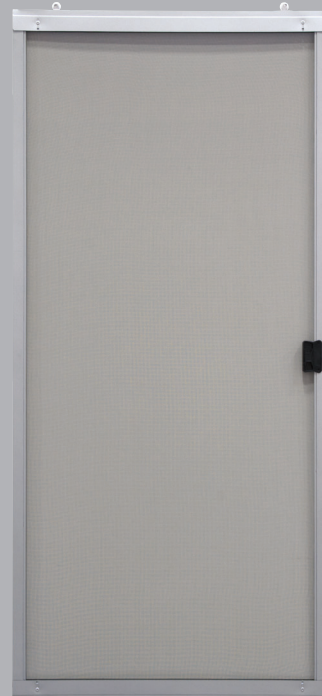

3700 (Assembled)
Product Line: D3005

Standard sizes available

30"
36"
48"

Economy Roll Form Steel Screen Door



Features

- 1-5/8" Roll form steel frame with hat section
- Height adjustable from 79-3/8" to 80-3/4" (for height adjustments between 78-1/8" and 79", remove top hood assembly)
- 36" & 48" Standard size only
- Black plastic "Superior" handle assembly
- Non-handed
- Stamped steel corners
- Charcoal fiberglass insect screening
- Nylon spring tension roller assembly
- Extruded vinyl bug seal with flap & tear-off strips
- No custom sizes or options
- Precision SAFEGUARD packaging - complete with hardware

Standard Finishes

- Bronze, gray or white

3751 (Assembled)

Product Line: D3005

Standard sizes available

36"
48"

MAUI (Series 3600 Assembled / 4600 KD)

Reinforced Vinyl Screen Door

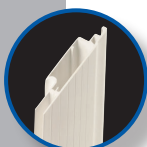

Features

- 2-1/4" x 1" Reinforced vinyl frame (smooth)
- Black plastic handle assembly
- Non-handed with handle centered
- Factory welded corners on assembled doors
- Heavy duty PVC corners with KD kits
- Charcoal fiberglass insect screening (on assembled doors)
- 1" Stainless steel ball bearing rollers with stainless steel adjusting screws
- Extruded vinyl bug seal with flap & tear-off strips
- **Specify handing: latch side, left or right as viewed from outside looking in**
- Assembled & K.D. widths available up to 61"
- Assembled & K.D. heights available up to 96"
- Corrosion resistant
- Cannot use Suntex on this door series
- Precision SAFEGUARD packaging - complete with hardware (on assembled doors)

Standard Finishes

- White vinyl

Call for quote on any sizes or options not shown

3600 (Assembled)

Product Line: D3600

Door size up to: *

37" x 81"	37" x 96"
49" x 81"	49" x 96"
61" x 81"	61" x 96"

4600 (KD)

Product Line: D3600

Door size up to:

37" x 81"	37" x 96"
49" x 81"	49" x 96"
61" x 81"	61" x 96"

*Dimension tolerances on assembled doors +/- 3/32" (3/16" overall)

SLIDING SCREEN DOORS

Custom options (add-ons)









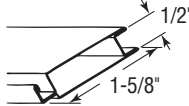

Option	Option Code	Description
Door frame options	OP-1PB-1	Install 1 each #288PB – 1-1/8" extruded push bar
	OP-1PB-2	Install 2 each #288PB – 1-1/8" extruded push bar
	OP-CRNSCR	Install 4 screws in each corner; total 16 screws
	OP-NOSLOT-HARDW	No latch, handles, rollers; no punch or slotting
	OP-SLSLOT4HNDL	Sliding door handle height; punch XX-x/x" up from bottom to
Roller options	OP-CLASSIC-N	Install classic side adjust nylon rollers (#477002N)
	OP-MARQUIS-NB	Slot & install Marquis nylon ball bearing rollers bottom (#4828N)
	OP-MARQUIS-NT	Slot & install Marquis nylon ball bearing rollers top (#4830)
	OP-MARQUIS-NTB	Slot & install Marquis nylon ball bearing rollers top & bottom (#4830 & #4828N)
	OP-MARQUIS-SB	Slot & install Marquis steel ball bearing rollers bottom (#4828)
	OP-MARQUIS-ST	Slot & install Marquis steel ball bearing rollers top (#4830)
	OP-MARQUIS-STB	Slot & install Marquis steel ball bearing rollers top & bottom (#4830 & #4828)
	OP-MARQUIS-SSB	Slot & install Marquis stainless steel ball bearing rollers bottom (#4828SS)
	OP-MARQUIS-SST	Slot & install Marquis stainless steel ball bearing rollers top (#4830SS)
	OP-MARQUIS-SSTB	Slot & install marquis stainless steel ball bearing rollers top & bottom (#4830SS & #4828SS)
	OP-REGAL-S	Install Regal steel rollers top & bottom #4131
	OP-REGAL-SS	Install Regal stainless steel ball bearing rollers #4131-SS
Handing options	OP-HNDLLEFT	XO"" Handle left from the outside looking in
	OP-HNDLRIGHT	OX"" Handle right from the outside looking in
Handle options	OP-1HNDL4227	Install Anjac handle #4227
	OP-2HNDL4227	Install Anjac handle #4227
	OP-1HNDL4230	Install Superior handle #4230
	OP-1HNDL4736	Install latch & flush handle inside & out #4736 w/latch
	OP-1HNDL4736-NS	No slot/no latch, install flush handles inside & out #4736
Grille options	OP-GREMPRESS-30	Install Empress heavy duty grille 30"
	OP-GREMPRESS-36	Install Empress heavy duty grille 36"
	OP-GREMPRESS-48	Install Empress heavy duty grille 48"
	OP-GREMPRESS-60	Install Empress heavy duty grille 60"
	OP-GRFIESTA-30	Install Fiesta grille 30"
	OP-GRFIESTA-36	Install Fiesta grille 36"
	OP-GRFIESTA-48	Install Fiesta grille 48"
	OP-GRFIESTA-60	Install Fiesta grille 60"

SLIDING SCREEN DOORS

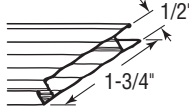
Custom options (add-ons)

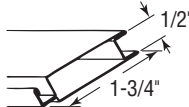
Option	Option Code	Description
Pet door options	OP-PD-SLD-S	Install pet door handle side – small w/adapter
	OP-PD-SLD-M	Install pet door handle side – medium w/adapter
	OP-PD-SLD-L	Install pet door handle side – large w/adapter
Pet door colors	OP-AD	Adobe
	OP-AL	Almond
	OP-BZ	Bronze
	OP-SA	Satin anodized
	OP-WH	White
Screen cloth options	OP-SC14CF	Screen cloth charcoal fiber 18" x 14"
	OP-SC14GF	Screen cloth gray fiber 18" x 14"
	OP-SC16BA	Screen cloth brite aluminum 18" x 16"
	OP-SC16BV	Screen cloth better vue
	OP-SC16CA	Screen cloth charcoal aluminum 18" x 16"
	OP-SC16CF	Screen cloth charcoal fiber 18" x 16"
	OP-SC16GF	Screen cloth gray fiber 18" x 16"
	OP-SC16UV	Screen cloth ultra vue
	OP-SC20CF	Screen cloth charcoal fiber 20" x 20"
	OP-SCD	Delete screen cloth & spline; door shell only
	OP-SCPSBK	Screen cloth black petscreen
	OP-SCPSLBK	Screen cloth black petscreen lite
	OP-SCPSGR	Screen cloth gray petscreen
	OP-SCSSCF	Screen cloth charcoal sunscreen
	OP-SCSSGF	Screen cloth gray sunscreen
	OP-SCSTBK	Screen cloth black sun tex 80%
	OP-SCSTBR	Screen cloth brown sun tex 80%
	OP-SCSTGR	Screen cloth gray sun tex 80%
OP-SCSTST	Screen cloth stucco sun tex 80%	

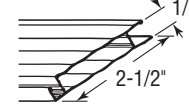
SLIDING SCREEN DOORS Assembled lines only

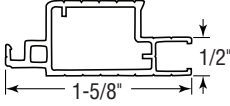
Name/ Series	Product Line	Description	Name/ Series	Product Line	Description
Brentwood 3100 Page 62	D3301	 <p>1-5/8" Roll form aluminum frame Custom widths 37" up to 61", Heights up to 97" Black plastic Anjac handle assembly with strike plate & installation screws Bronze, gray or white No custom colors available for this door</p> 	Prestige 3500 Page 64	D3302	 <p>2-1/4" x 1" .050 Extruded "hat section" style aluminum frame (smooth) Custom widths 37" up to 73", Heights up to 110" * Recessed handle assembly with mortise lock & slide latch Adobe, almond, bronze or white Satin anodized No custom colors available for this door</p> 
Regal 3200 Page 62	D3302	 <p>1-3/4" .050 Extruded aluminum frame (fluted) Custom widths 37" up to 73", Heights up to 110" * Extruded aluminum handle assembly with mortise lock & lever latch Adobe, almond, black, bronze or white Satin anodized No custom colors available for this door</p> 	Breezeway 3700 Page 64	D3005	 <p>1-5/8" Roll form steel frame Available in 30", 36" & 48" only Black plastic "Precision" handle assembly Bronze, gray or white No custom sizes or colors available for this door</p>
Classic 3300 Page 63	D3302	 <p>1-3/4" .050 Extruded aluminum frame Custom widths 37" up to 73", Heights up to 110" * Extruded aluminum handle assembly with mortise lock & lever latch Adobe, almond, black, bronze or white Bronze or satin anodized No custom colors available for this door</p> 	Branson 3751 Page 65	D3005	 <p>1-5/8" Roll form steel frame with hat section Available in 36" & 48" only Black plastic "Superior" handle assembly Bronze, gray or white No custom sizes or colors available for this door</p>
Marquis 3400 Page 63	D3302	 <p>2-1/2" .060 Extruded aluminum frame (fluted) Custom widths 37" up to 73", Heights up to 110" * Extruded aluminum handle assembly with mortise lock & lever latch Adobe, almond, black, bronze or white Satin anodized No custom colors available for this door</p> 	Maui 3600 Page 65	D3600	 <p>2-1/4" x 1" Reinforced vinyl frame (smooth) Custom widths 37" up to 61", Heights up to 96" Black plastic handle assembly Corrosion resistant White No custom colors available for this door</p> 

***Extra charges will apply for doors over 97" in height**

TOP HUNG UNIVERSAL MOUNTING CHANNEL

For sliding screen doors

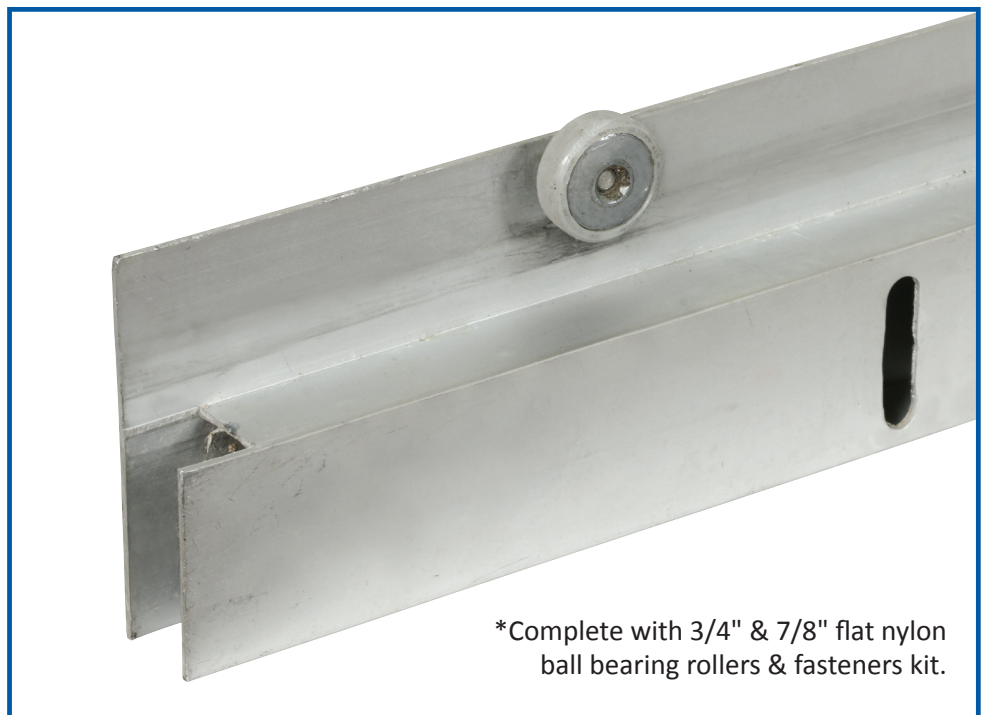
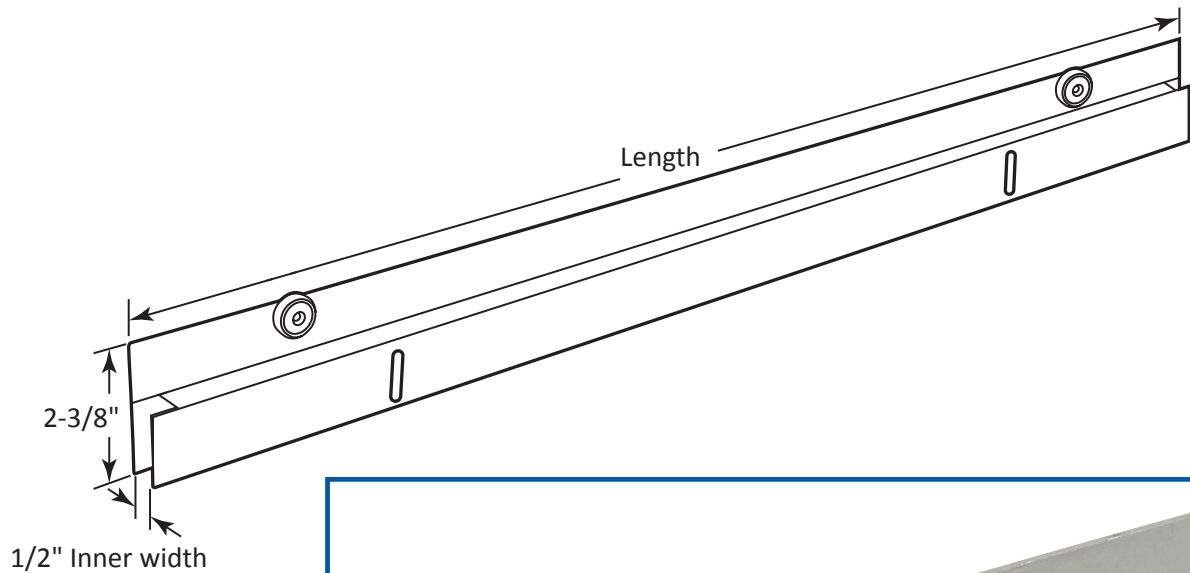

*** FITS MOST DOOR SERIES**
BRENTWOOD, REGAL, CLASSIC, MARQUIS

4848AD-36
4848AL-36
4848BZ-36
4848SA-36
4848WH-36

4848AD-48
4848AL-48
4848BZ-48
4848SA-48
4848WH-48

SLIDING SCREEN COMPONENTS

Color code chart (xx)		
AD = Adobe	BK = Black	ML = Mill
AL = Almond	BZ = Bronze	SA = Satin anodized
BA = Bronze anodized	GR = Gray	WH = White

Part No.	Product Line	Description	Drawing
4180xx	F3874	5/8" x 1" Top single track 12' <i>(Available in all colors except gray)</i>	
4181xx	F3874	5/8" x 1" Top double track 12' <i>(Available in all colors except gray)</i>	
4184xx	F3874	Bottom double track 12' <i>(Available in all colors except gray)</i>	
4185xx	F3874	Single bottom track 12' <i>(Available in all colors except gray)</i>	
4189WH-8 4189WH	F3870 F3870	Extruded vinyl track 8' Extruded vinyl track 16' <i>(Available in white only)</i>	
4195xx	F3874	5/8" x 1/2" Top single track 12' <i>(Available in all colors except gray)</i>	
4198xx-84 4198BK-96 4198xx-100	F3874 F3874 F3874	Rigid vinyl astragal - 84" (all available colors) Rigid vinyl astragal - 96" (black only) Rigid vinyl astragal - 100" (AL not available) <i>(Available colors: AD, AL, BK, BZ, GR & WH)</i>	
4199xx84 4199xx	F3874 F3874	Used for extruded sliders Extruded screen astragal - 7' Extruded screen astragal - 8' <i>(Available in all colors except gray)</i>	

SLIDING PATIO SCREEN DOOR

Measuring worksheet

Step #1

Determine type of header:

Determine what type of header you have; **Top "track"** or **Top "channel"** from the 2 examples in *Diagram A* on the right.

*Note: If your door is something other than either of the examples in *Diagram A*, we recommend using Lowe's Installation professionals.

Step #2

Determine Door Height:

To determine the height of your door, measure from the top of the screen door **Top "track"** or **Top "channel"** to the top of the **"bottom sliding screen door track"** as shown.

Make height measurements in 3 locations, the center and each end. There may be some "Sag", "Dip" or "Crown" along the door frame on older homes, so use the **SHORTEST** measurement for the final height of your door using the formula in *Diagram A*.

Example: using *Diagram A* formulas and shortest measurement for a door being 80":

"track" formula: $80" + 1/4" = 80-1/4"$

"channel" formula: $80" - 1/4" = 79-3/4"$

Net Door Height: _____ "

Step #3

Determine Door Width:

To determine the width, measure from the edge of the side jamb to approximately 1" past the "sliding" glass door panel (see *Diagram B*)

Net Door Width: _____ "

Step #4

Handle:

Please specify placement as either left or right as seen looking from the outside of the door in. (*Right hand showing in diagram*)

Handle side: Left Right

Step #5

Handle Height:

Handle will be centered unless specified. To order a special handle height placement, measure from the bottom of the door to center of handle.

Special Handle Height: _____ "
(Not required for normal installations)

Note: If you have an existing OEM Screen Door, compare your measurements with the size of the door that you are replacing.

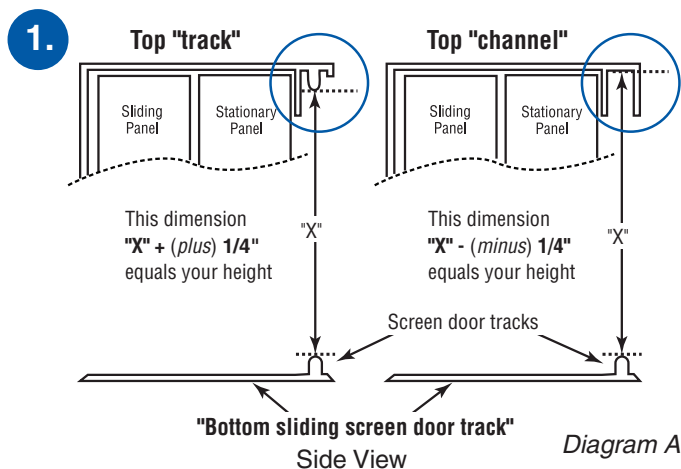

2. Determine Height

3. Determine Width

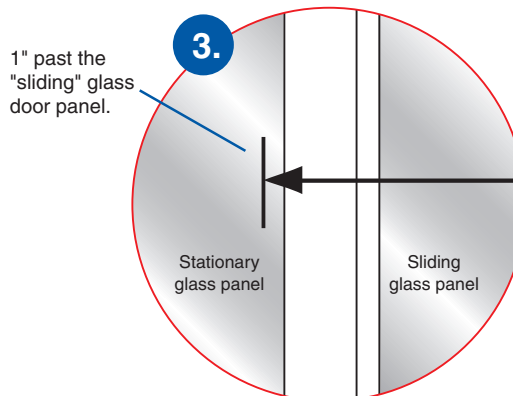
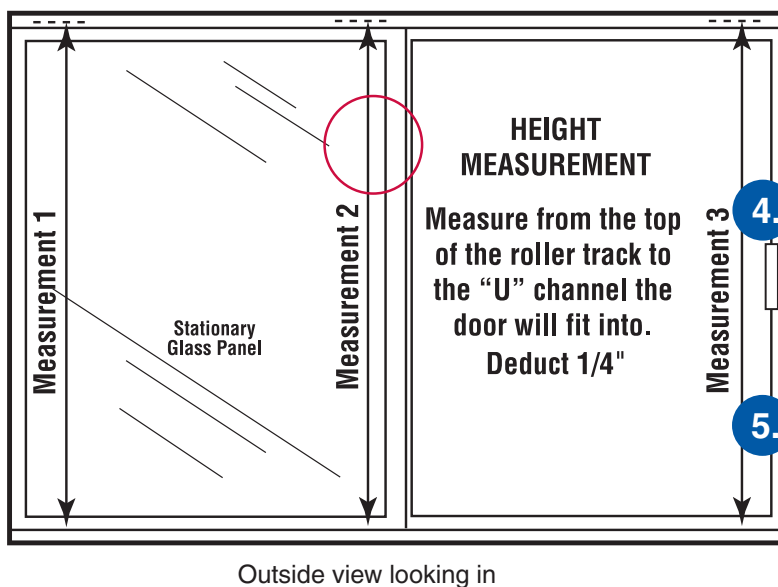

Diagram B

Patio Door Quick Fax Form

Fax to (909) 379-0169

Phone (909) 379-0123 • (866) 629-6636

Customer Name _____ Acct # _____ Customer Phone# _____

Contact Name _____ Customer Fax # _____

PO # Job/Customer Name _____ **QUOTE ONLY** **ORDER**

Qty	Net Door Size	Door Name	Door Color	Screen (Fabric / Color)	Handle Side	Handle Height	Notes & Options Instructions

**Note: Specify Handle side from the outside looking in.*